

1		
Description	Material	Finish
Body	Brass	Nickel
Pin	Brass	Gold
Insulation	Teflon	Teflon
Washer	Brass	Nickel
Nut	Brass	Nickel

TOP VIEW

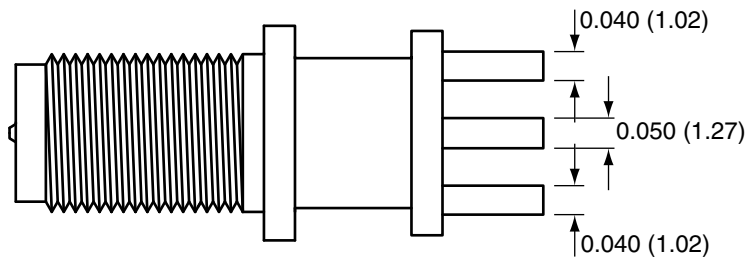

MOUNTING METHODS

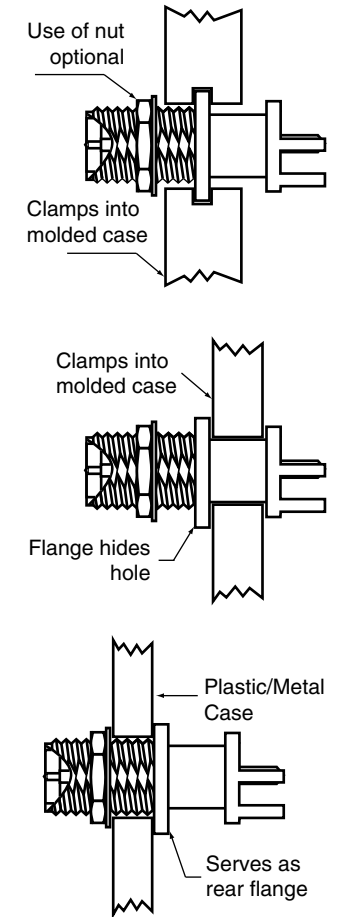

SIDE VIEW

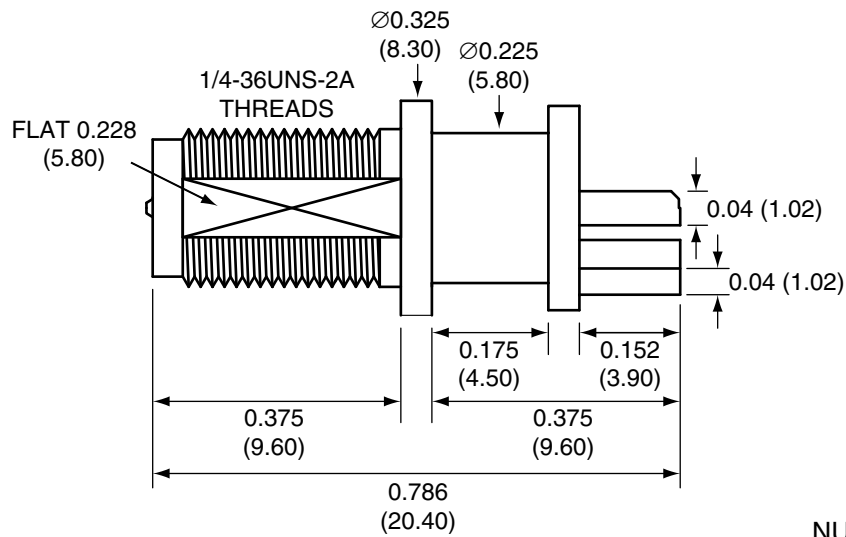

BACK VIEW

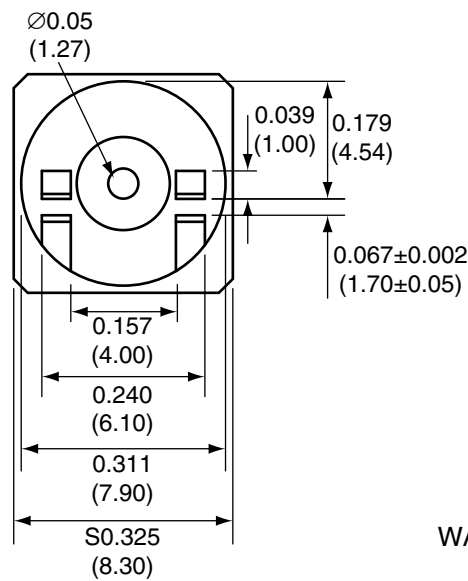

NUT

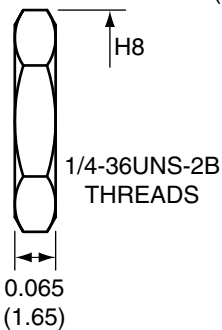

WASHER

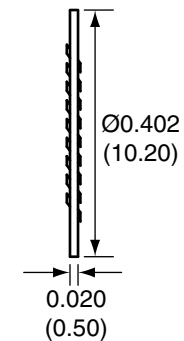

RECOMMENDED FOOTPRINT

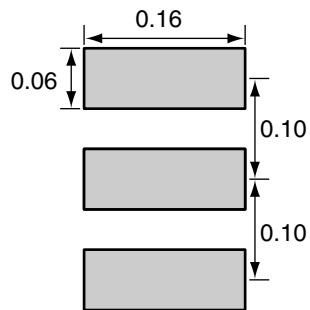

RECOMMENDED MOUNTING HOLE

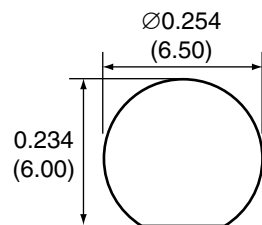

Title RP-SMA FEMALE EDGE MULTI-MOUNT
W/ SQUARE FLANGE FOR 0.062" THICK BOARD

Part No. CONREVSMA006.062SQ Revision: 1.0

Dimensions: INCHES (mm) Date: 3/2/2005

CONNECTOR CITY
159 ORT LANE
MERLIN, OR 97532
PH (541)-471-6256
FAX (541)-471-6251

Sheet 1 of 1

CONNECTOR CITY
THE VALUE OF CONNECTIONS